

PRODUCT NO.	1
RoHS compliant	

REV.	ECN NO.	DR	DATE

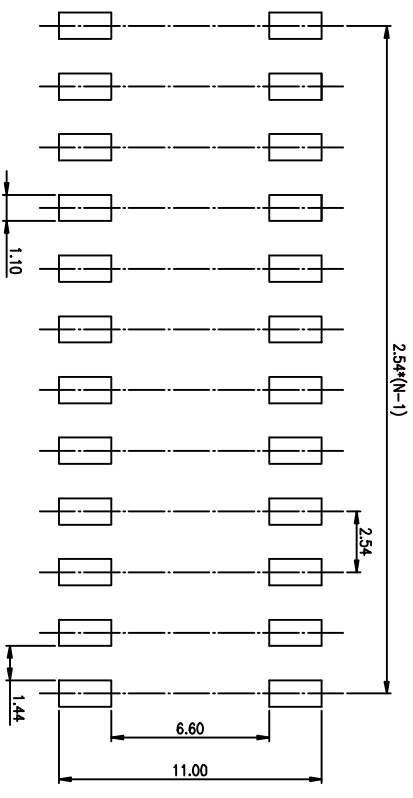
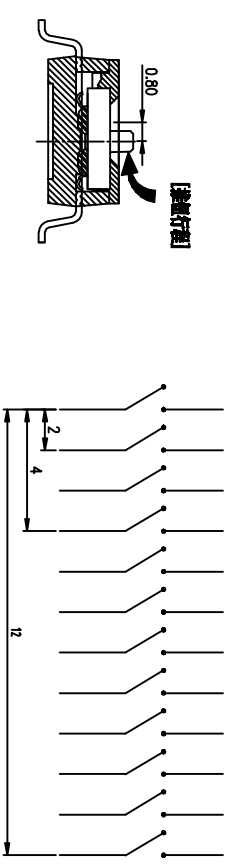
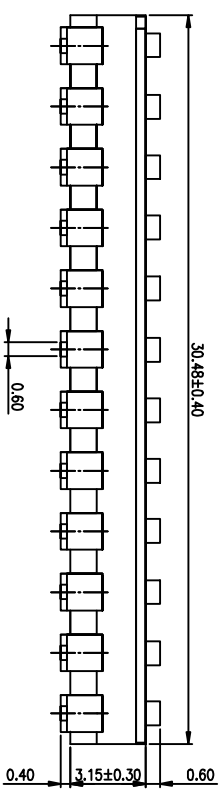
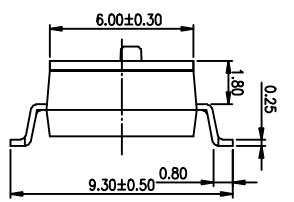
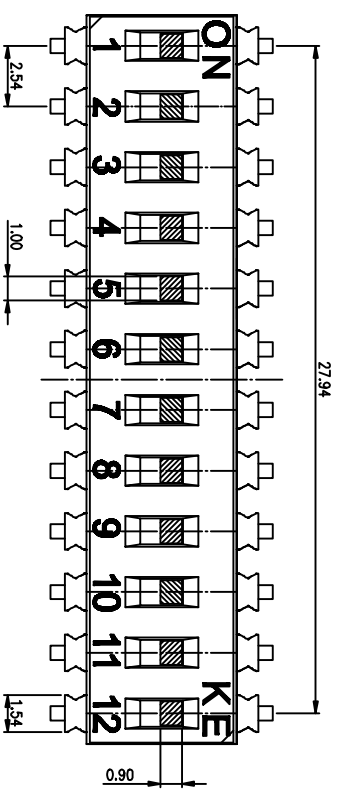

- NOTES :
- 1> Specification:
 - 1> Operating force: 1000gf Max
 - 2> Operating Temperature: -40° to+85°
 - 3> Storage Temperature: -40° to+85°
 - 4> Mechanical Life: 3000cycles minimum
 - 5> Electrical Life: 2000cycles minimum
 2. PLATING:
 - GOLD FLASH 1u"(min.) SOLDER TAIL,
 - 3u" GOLD PLATING ON THE CONTACT AREA,
 - WITH 50u" NICKEL UNDERPLATINGOVERALL.

3. PART NUMBER DESCRIPTION

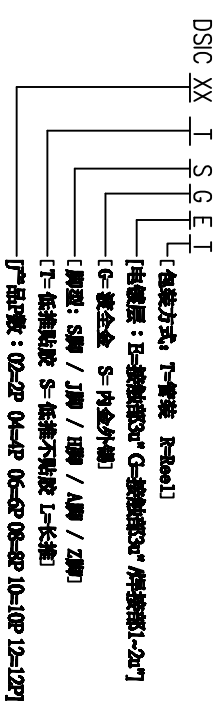

RECOMMENDED P.C.B. LAYOUT (TOP VIEW)

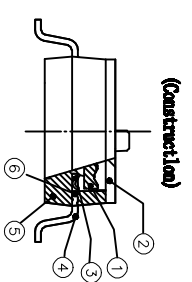

Number	Part Name	Material	Finished
①	Actuator	UL94 V0	White
②	Cover	UL94 V0	Black
③	Movable	Copper Alloy	3u"Gold
④	Terminal	Brass	1u"Gold
⑤	Base	UL94 V0	Black
⑥	Terminal Contact	Brass	3u"Gold

TOLERANCE UNLESS OTHERWISE SPECIFIED		INSPECTION COPY	
LINER	ANGLES	PROJECTION	COPY
0 ± 0.25	0. ± 2'		
.00 ± 0.15	.0 ± 1'		
.000± 0.10	.00± 0.5'		
DESIGN	kathy	2012/04/12	
DRAWING			
CHECK			
APPRO.			

东莞市金捷电子有限公司 Dongguan Kingtek Industrial Co., Ltd.			
TITLE			
BY DISC SERIES PITCH 2.54mm			
PRODUCT FAMILY DISC SERIES			
PRAT NO. DISC12LSGET			
FILE NO.	DISC12LSGET-A	UNIT SCALE	SHEET REV.
SIZE	A4	mm	2 : 1 1 OF 1 A