

PRODUCT NO.	DISC08SJGET
RoHS compliant	

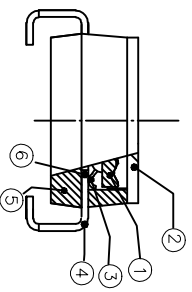
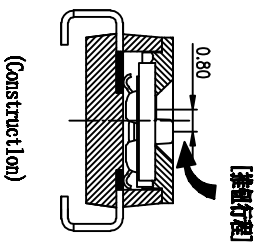
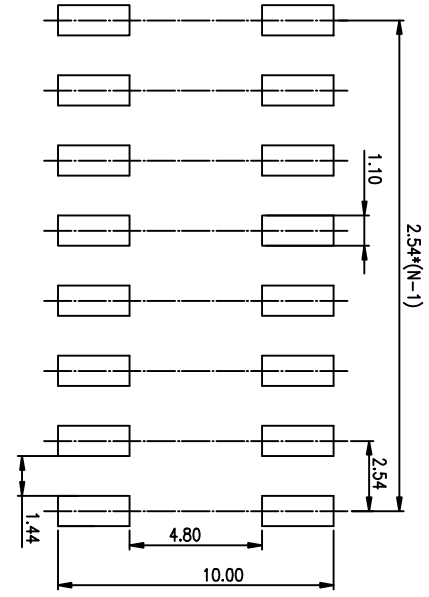
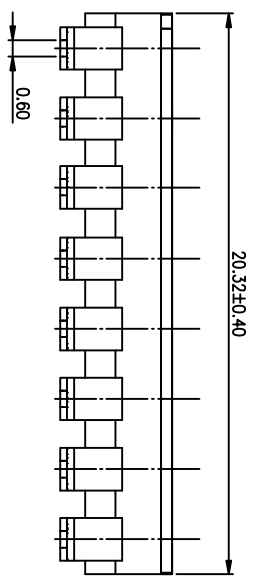
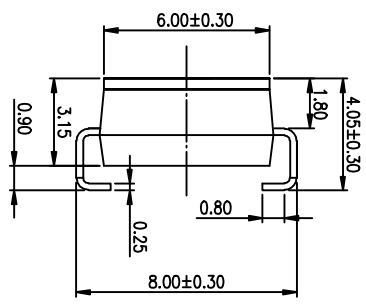
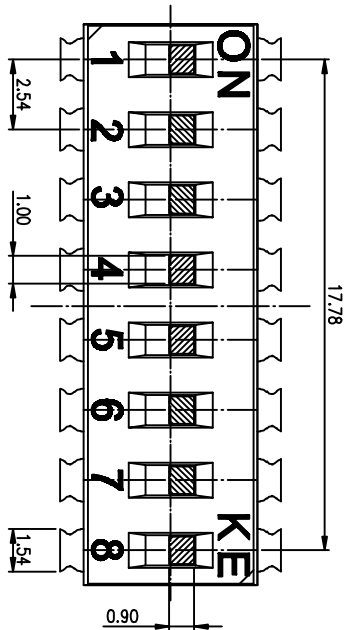

**RECOMMENDED P.C.B. LAYOUT (TOP VIEW)**

- NOTES :
- 1> Specification:
- 1> Operating force: 1000gf Max
  - 2> Operating Temperature: -40° to +85°
  - 3> Storage Temperature: -40° to +85°
  - 4> Mechanical Life: 3000cycles minimum
  - 5> Electrical Life: 2000cycles 25mA 24VDC
2. PLATING:
- GOLD FLASH 1u"(min.) SOLDER TAIL,
  - 3u" GOLD PLATING ON THE CONTACT AREA,
  - WITH 50u" NICKEL UNDERPLATING OVERALL.

3. PART NUMBER DESCRIPTION

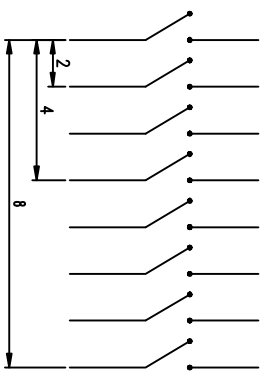
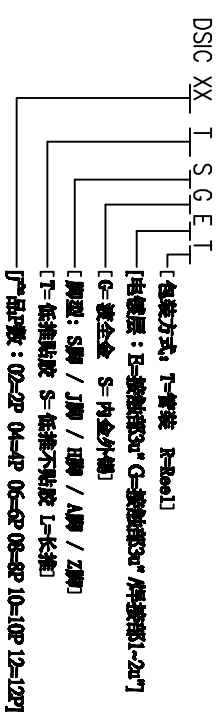

Number	Part Name	Material	Finished
①	Actuator	UL94 V0	White
②	Cover	UL94 V0	Black
③	Movable	Copper Alloy	3u"Gold
④	Terminal	Brass	1u"Gold
⑤	Base	UL94 V0	Black
⑥	Terminal Contact	Brass	3u"Gold

TOLERANCE UNLESS OTHERWISE SPECIFIED		INSPECTION COPY	
LINER	ANGLES	PROJECTION	COPY
0 ± 0.25	0. ± 2'		
.00 ± 0.15	.0 ± 1'		
.000 ± 0.10	.00 ± 0.5'	DESIGN: kathy 2012/04/12 PRODUCT FAMILY DISC SERIES PRAT NO. DISC08SJGET	
DRAWING CHECK		FILE NO. DISC08SJGET-A	
APPRO.		SIZE UNIT SCALE SHEET REV.	
		A4 mm 2 : 1 1 OF 1 A	

**RE** 總發精密電子股份有限公司  
Dongguan Kingtek Industrial Co., Ltd.