

PRODUCT NO.	DISC08LJGET
RoHS compliant	

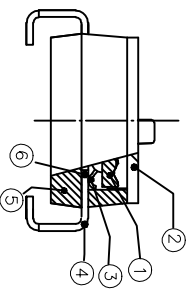
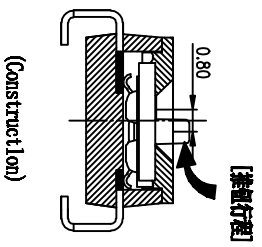
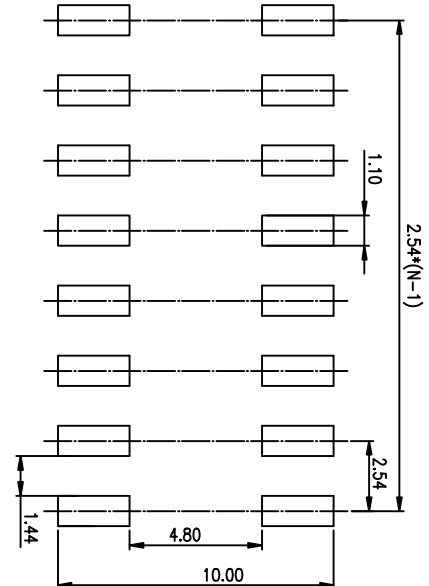
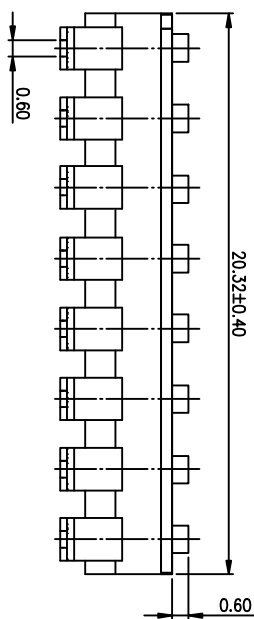
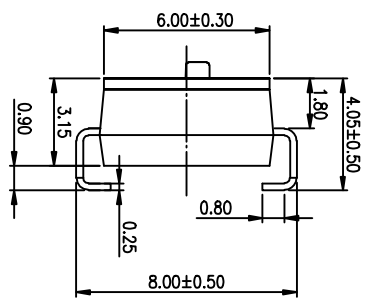
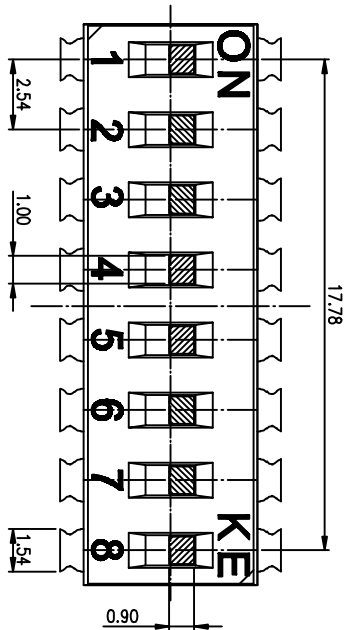

RECOMMENDED P.C.B. LAYOUT (TOP VIEW)

- NOTES :
- 1> Specification:
- 1> Operating force: 1000gf Max
 - 2> Operating Temperature: -40° to +85°
 - 3> Storage Temperature: -40° to +85°
 - 4> Mechanical Life: 3000cycles minimum
 - 5> Electrical Life: 2000cycles 25mA 24VDC
2. PLATING:
- GOLD FLASH 1u"(min.) SOLDER TAIL,
 - 3u" GOLD PLATING ON THE CONTACT AREA,
 - WITH 50u" NICKEL UNDERPLATING OVERALL.

3. PART NUMBER DESCRIPTION

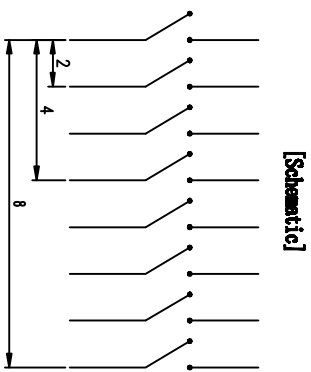
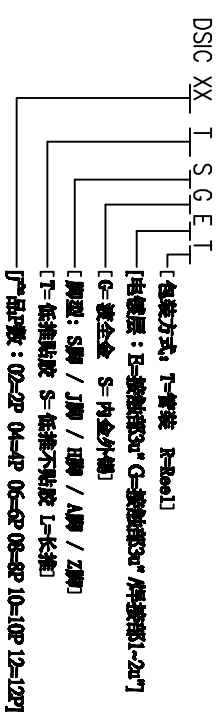

Number	Part Name	Material	Finished
①	Actuator	UL94 V0	White
②	Cover	UL94 V0	Black
③	Movable	Copper Alloy	3u"Gold
④	Terminal	Brass	1u"Gold
⑤	Base	UL94 V0	Black
⑥	Terminal Contact	Brass	3u"Gold

TOLERANCE UNLESS OTHERWISE SPECIFIED		INSPECTION	
LINER	ANGLES	COPY	PROJECTION
0 ± 0.25	0. ± 2°		
.00 ± 0.15	.0 ± 1°		
.000 ± 0.10	.00 ± 0.5°		
DESIGN	kathy	2012/04/12	
CHECK			
APPRO.			

RE 瑞智精控電子股份有限公司
Dongguan Kingtek Industrial Co., Ltd.

FILE NO.	DISC08LJGET-A
SIZE	UNIT SCALE SHEET REV.
A4	mm 2 : 1 1 OF 1 A