

PRODUCT NO. DSIC07LJGET	RoHS compliant
-----------------------------------	-----------------------

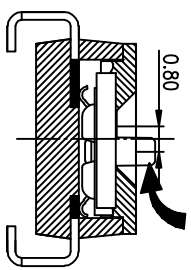

(Construction)

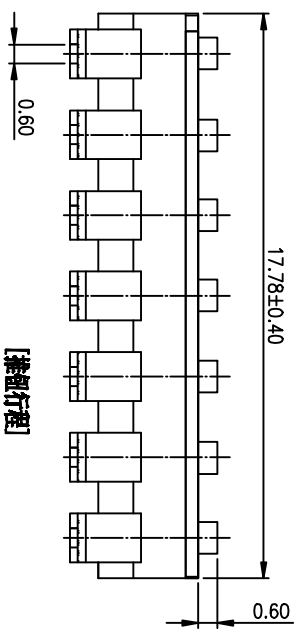
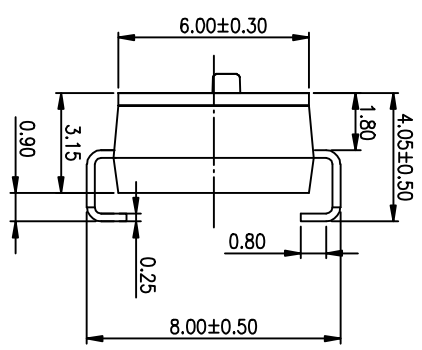
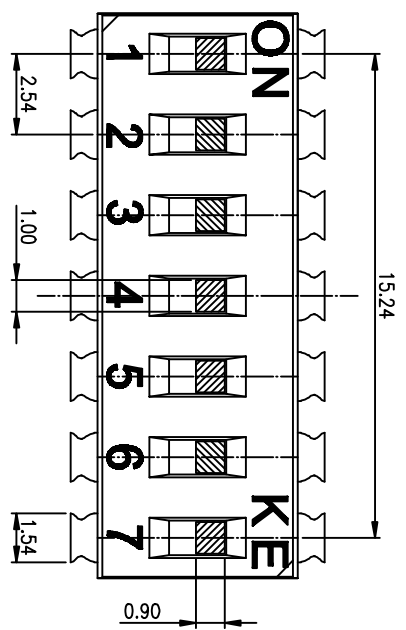
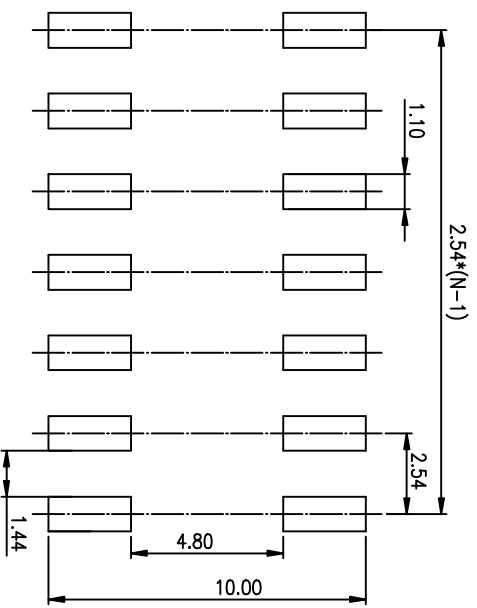
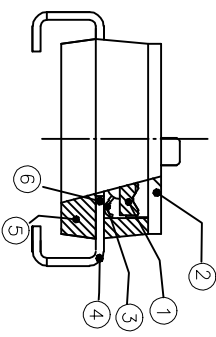

RECOMMENDED P.C.B. LAYOUT (TOP VIEW)

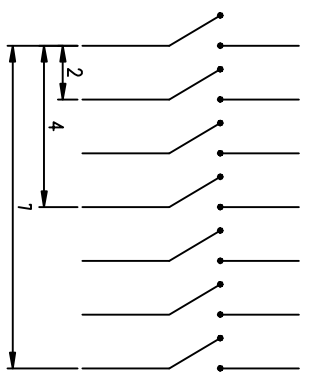

[Schematic]

- NOTES :
- 1>.Specification:
- 1>.Operating force: 1000gf Max
 - 2>.Operating Temperature: -40° to+85°
 - 3>.Storage Temperature: -40° to+85°
 - 4>.Mechanical Life: 3000cycles minimum
 - 5>.Electrical Life: 2000cycles 25mA 24VDC
2. PLATING:
- GOLD FLASH 1u"(min.) SOLDER TAIL,
 - 3u" GOLD PLATING ON THE CONTACT AREA,
 - WITH 50u" NICKEL UNDERPLATINGOVERALL.

3. PART NUMBER DESCRIPTION

- DSIC XX I S G E T
- [包裝方式: T=管裝 R=盒裝]
 - [電鍍層: B=鍍鍍3u" G=鍍鍍3u" / 鍍鍍3u"-2u"]
 - [G=鍍金 S=內金少鍍]
 - [測試: S牌 / J牌 / 瑞 / A牌 / Z牌]
 - [T=低溫耐受 S=低溫不耐受 L=長推]
 - [T=低溫: 02=2P 04=4P 06=6P 08=8P 10=10P 12=12P]

Number	Part Name	Material	Finished
①	Actuator	UL94 V0	White
②	Cover	UL94 V0	Black
③	Movable	Copper Alloy	3u"Gold
④	Terminal	Brass	1u"Gold
⑤	Base	UL94 V0	Black
⑥	Terminal Contact	Brass	3u"Gold

TOLERANCE UNLESS OTHERWISE SPECIFIED		INSPECTION COPY	
LINER	ANGLES	PROJECTION	COPY
0 ± 0.25	0. ± 2'		BY DSIC SERIES PITCH 2.54mm
.00 ± 0.15	.0 ± 1'		
.000± 0.10	.00± 0.5'	DESIGN	2012/04/12
DRAWING		PRAT NO.	DSIC07LJGET
CHECK		FILE NO.	DSIC07LJGET-A
APPRO.		SIZE	UNIT SCALE SHEET REV.
		A4	mm 2 : 1 10F 1 A

東富精機電子股份有限公司
Dongfuchen Kingtek Industrial Co., Ltd.