

PRODUCT NO.	DSIC02SUGET
ROHS COMPLIANT	

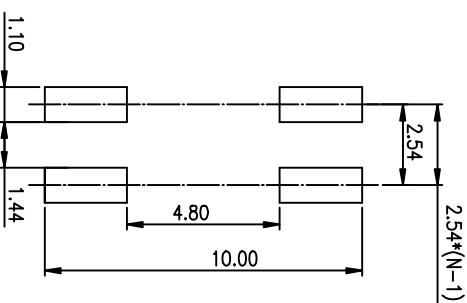

RECOMMENDED P.C.B. LAYOUT (TOP VIEW)

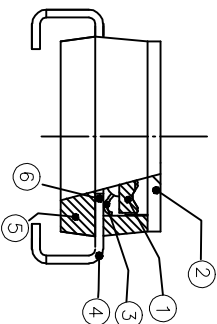
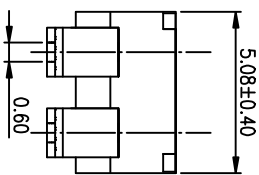
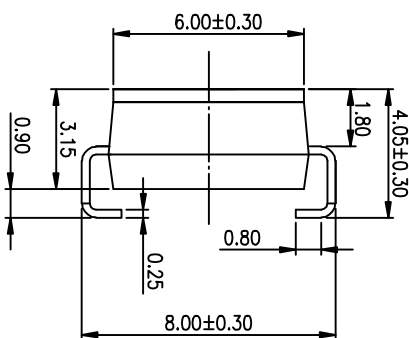
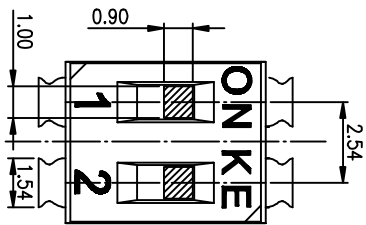
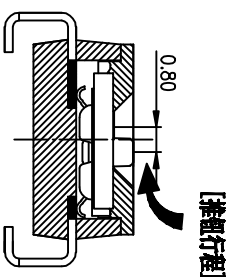
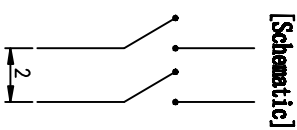

- NOTES :
- 1>.Specification:
- 1>.Operating force:1000gf Max
 - 2>.Operating Temperature: -40° to+85°
 - 3>.Storage Temperature: -40° to+85°
 - 4>.Mechanical Life: 3000cycles minimum
 - 5>.Electrical Life: 2000cycles 25mA 24VDC
2. PLATING:
- GOLD FLASH 1u"(min.) SOLDER TAIL,
3u" GOLD PLATING ON THE CONTACT AREA,
WITH 50u" NICKEL UNDERPLATINGOVERALL.

3. PART NUMBER DESCRIPTION

DSIC XX T S G E T

- [包装方式: T=管装 R=盒装]
- [电镀层: B=镀锡3u" G=镀镍3u" / 厚镍3u"-2u"]
- [G=鍍金 S=內金外鍍]
- [脚型: S脚 / J脚 / 環 / A脚 / Z脚]
- [T=低接触度 S=低接触度 L=长推]
- [产品规格: 02=2P 04=4P 06=6P 08=8P 10=10P 12=12P]

Number	Part Name	Material	Finished
①	Actuator	UL94 V0	White
②	Cover	UL94 V0	Black
③	Movable	Copper Alloy	3u"Gold
④	Terminal	Brass	1u"Gold
⑤	Base	UL94 V0	Black
⑥	Terminal Contact	Brass	3u"Gold

TOLERANCE UNLESS OTHERWISE SPECIFIED		IN/INSPECTION	
LINER	ANGLES	COPY	PROJECTION
0 ± 0.25	0. ± 2°		
.00 ± 0.15	.0 ± 1°		
.000± 0.10	.00± 0.5°		
DESIGN	kathy	2012/04/12	
DRAWING			
CHECK			
APPRO.			

德普特电子股份有限公司
Dongguan Kingtek Industrial Co., Ltd.

BY DSIC SERIES PITCH 2.54mm

PRODUCT FAMILY DSIC SERIES

PRAT NO. DSIC02SUGET

FILE NO. DSIC02SUGET-A

SIZE UNIT SCALE SHEET REV.

A4 mm 2 : 1 1OF 1 A